

## POKER

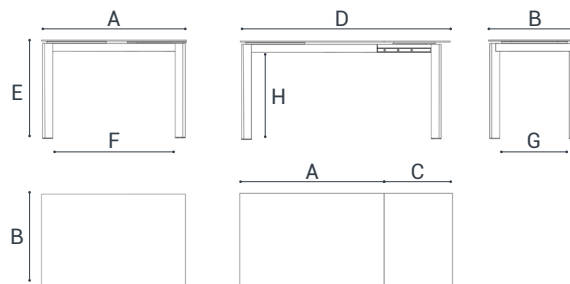

## DONNÉES TECHNIQUES | TECHNISCHE ANGABEN

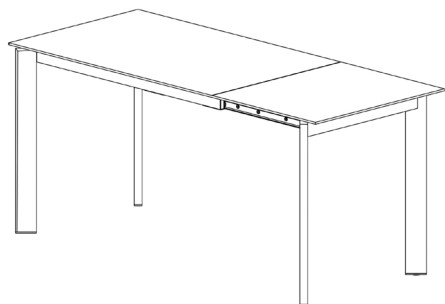

cm	A	B	C	D	E	F	G	H			
100x50	100	50	60x1	160	75	87	35	67	1	2	3
110x70	110	70	60x1	170	75	93	53	67	1	4	6
115x65	115	65	60x1	175	75	98	48	67	1	6	8
120x80	120	80	60x1	180	75	103	63	67	1	6	8



**Nombre de rallonges**  
Anzahl der Ausziehbaren



**Places table fermée**  
Sitzplätze Tisch geschlossen



**Places table ouverte**  
Sitzplätze Tisch offen



**VERSION EXTENSIBLE**  
AUSZIEHBARE  
AUSFÜHRUNG



**Section des pieds:**  
Querschnitt des Beins:  
70x30 mm (100x50) | 80x30 mm (110x70, 115x65, 120x80)



**Rallonges relevables**  
Ausziehbare mit  
Höheverstellung



**Pied mobile avec roue**  
Bewegbares Bein  
mit Rad



**Nivellement allonge-plateau**  
Höhenausgleich  
Ausziehbaren-Arbeitsfläche

## MATÉRIAUX | MATERIALIEN



**MATÉRIAUX:**  
MATERIALIEN:

**Pieds: Acier peint epoxy**  
Beine: Stahl epoxy

**Armature: Acier peint epoxy**  
Gerüst: Stahl epoxy

**Plateau et Rallonges: Verre trempé | Céramique**  
Arbeitsfläche und Ausziehbare: Sicherheitsglas | Keramik

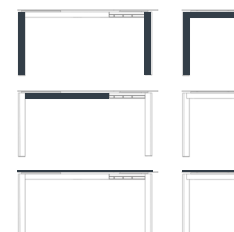

**ÉPAISSEUR PLATEAU:**  
DICKE DER ARBEITSFLÄCHE:

**Verre**  
Glas 8mm | 8 mm Verre Trempé | Sicherheitsglas

**Céramique**  
Keramik 11mm | + 3 mm Céramique | Keramik  
+ 8 mm Verre Trempé | Sicherheitsglas

**FINITIONS | AUSFÜHRUNGEN**















**PIEDS | BEINE**



- |                            |   |  |   |   |
|----------------------------|---|--|---|---|
| Acier Epoxy<br>Epoxi Stahl |  Blanc<br>Weiß |  Aluminium<br>Aluminium |  Anthracite<br>Anthrazit |  Noir<br>Schwarz |
|----------------------------|---|--|---|---|

**PLATEAU | ARBEITSFLÄCHE**



- |                      |   |  |  |   |   |
|----------------------|---|--|--|---|---|
| Verre<br>Glas        | C |  Anthracite Brillant<br>Anthrazit Glanz |  Noir Brillant<br>Schwarz Glanz |  Rouge Brillant<br>Rot Glanz |  Tourterelle Brillant<br>Taupe Glanz |
|                      | D |  Blanc Brillant<br>Weiß Glanz           |  Blanc Dépoli<br>Weiß Matt      |   |   |
| Céramique<br>Keramik | E |  Beton                                  |  Cement                         |  Basalt                      |  Nero                                |
|                      | F |  Artic                                  |  Calacatta                      |  Iron Moss                   |   |

**ARMATURE | GERÜST**

 Toujours la même couleur que les pieds  
Immer die gleiche Farbe wie Beine

**RALLONGES | AUSZIEHBARE**

 Toujours la même couleur que le plateau  
Immer die gleiche Farbe wie Arbeitsfläche